



# Cascade 700

INSTALLATION AND OPERATING INSTRUCTIONS. READ INSTRUCTIONS CAREFULLY BEFORE ATTEMPTING INSTALLATION.  
KEEP THESE INSTRUCTIONS FOR FUTURE REFERENCE

## GB

### ATTENTION

**AUTOMATIC CUT-OUT.** To help ensure your pump's long life and to prevent damage, it is fitted with automatic thermal overload protection. This switches off the pump if it overheats. If this occurs, switch off the power at the mains supply to the pump. Check for the cause. Usually it will be debris blocking the inlets of the pump or obstructing the impeller. Remove the obstruction and wait 15 minutes for the pump to cool down and automatically reset. Then switch on the pump again.

**NOTE: YOU MUST SWITCH OFF THE MAINS SUPPLY BEFORE THE PUMP WILL RESET.**

From 1st January 2005 installing this product in the garden is classed as 'notifiable' in the revised Building Regulations for England and Wales. The Regulations now require you to tell your local authority building control department that you intend to install this product before installation. Your local authority will let you know how you can get your installation approved.

The Hozelock Cyprio Cascade 700 pump is designed for submersible use only. The pump does not use oil or grease for lubrication and can be used safely in ponds containing fish or plants. The motor consists of a sealed stator and water-cooled permanent magnet rotor. All electrical components are isolated from the water.

### IMPORTANT

- WARNING: ALWAYS UNPLUG OR DISCONNECT ALL APPLIANCES IN THE POND FROM THE ELECTRICITY SUPPLY BEFORE PUTTING YOUR HANDS IN THE WATER WHILE EQUIPMENT IS BEING INSTALLED, REPAIRED, MAINTAINED OR HANDLED.**
- Do not use the supply cable to lift the pump, as this may cause damage. We recommend fitting a lifting cord to the handle eye on the top of the strainer cage when the pump is installed in deep water. See fig 1.
- Do not operate or leave the pump in freezing conditions.
- Do not allow the pump to run dry.
- Check that the voltage marked on the pump corresponds to the mains supply.
- A 10MA OR 30 MA RESIDUAL CURRENT DEVICE MUST BE FITTED TO THE MAINS SUPPLY.**
- DO NOT OPERATE THIS PUMP WITHOUT THE STRAINER CAGE ATTACHED. USING THE PUMP WITHOUT A STRAINER MAY INVALIDATE YOUR WARRANTY.**

### Safety Information

The appliance is not intended for use by persons (including children) with reduced physical, sensory or mental capabilities, or lack of experience and knowledge, unless they have been given supervision or instruction concerning use of the appliance by a person responsible for their safety. Children should be supervised to ensure that they do not play with the appliance.

**(Australia & NZ only)** This appliance is not intended for use by young children or infirm persons unless they have been adequately supervised by a responsible person to ensure that they can use the appliance safely.

Young children should be supervised to ensure that they do not play with the appliance.

### WARNING: SAFETY AND ELECTRICAL CONNECTIONS

- The pump is supplied with 10m of 3 core electric cable which is permanently connected and sealed to the motor. The supply cable cannot be replaced. If the cable is damaged, the pump should be discarded. This product is designed to be permanently wired to the mains supply in a dry weatherproof enclosure through a Double-Pole Switched Fused Spur - (Disconnector) to BS 3676, with a minimum contact separation of 3mm in each Pole - Fitted with a 3 or 5 Amp fuse. The installation must conform to the national and local wiring regulations which could include the use of plastic or metal conduit to protect the cable.
- A 10MA OR 30MA RESIDUAL CURRENT DEVICE (RCD) MUST BE FITTED TO THE MAINS SUPPLY.**
- WARNING: THIS APPLIANCE MUST BE EARTHED AND IT IS ESSENTIAL THAT THE CONNECTIONS ARE MADE USING THE FOLLOWING CODE;**



The BROWN lead should be connected to the LIVE terminal which may be marked with an 'L' or coloured brown or red. The BLUE lead should be connected to the NEUTRAL terminal which may be marked with an 'N' or coloured blue or black. The GREEN/YELLOW lead should be connected to the EARTH terminal which may be marked with an 'E' or coloured green or green/yellow.

- If an extension cable is required, this should be connected to the end of the pump cable using a weatherproof cable connector. The joint must be positioned in a suitable weatherproof housing. The extension cable should be of 3 core 0.75mm<sup>2</sup> Polychloroprene rubber insulated cable (ref: H05 RN-F) and permanently wired to the mains supply with a 3 or 5 Amp fuse.
- The pump cable (and extension cable) should be positioned and adequately protected against damage especially where contact with gardening equipment (lawn mowers, forks etc.) children and domestic animals may occur.
- CONSULT A QUALIFIED ELECTRICIAN OR LOCAL AUTHORITY IF IN ANY DOUBT ABOUT WIRING TO THE MAINS SUPPLY.**

### ACCESSORY ASSEMBLY

#### Telescopic Stem Assembly.

Take the outer telescopic stem 'A' and slide the inner stem 'B' into it, as shown. See Fig 2.

#### Bell Fountain

- Locate the Bell Support (D) to the Bell Main Body (E) and push fully home.
- Position the Bell (F) to the Body Assembly and press into the central location. See fig 3.

### PUMP INSTALLATION

#### Position

Construct a solid and level platform on which to place the pump. Which using spray fountains, the top of the platform should be 240-330mm (10-13") below the water surface. When using the bell fountain, the top of the platform should be 100mm (4") below the water level.

A typical installation is shown for guidance in fig 4.

#### Flow Control

The flow from the pump can be regulated to meet your needs by rotating the flow controller wheel (G) near the outlet of the pump. See Fig 5.

#### Fountain Only

- Place the pump next to the pond and route the cable back to the mains supply.
- Select the desired fountain accessory. The 2 and 3 tier fountainheads simply snap onto the fountain stem (See Fig 6). The fountain stem pushes onto the narrower tube section of the telescopic fountain stem (See Fig 6). Then place the pump in the desired position. Note: Check that the inner stem of the telescopic tube has not been pushed inside the outer tube.
- a) 3 tier fountain - Creates a wide and attractive fountain spray.  
b) 2 tier fountain - Creates a higher and narrower display.  
c) Bell fountain - Creates a decorative water bell. Adjust the telescopic stem to the required height and regulate the bell by rotating the flow controller by the outlet of pump and by sliding the inner bell in and out of the bell assembly.
- The ball joint - See Fig 5 (H), fits onto the

pump outlet and the telescopic stem pushes onto the top. This can then be used to adjust the fountain angle so that it is vertical.

### Waterfall Only

1. Fit a suitable length of hose 12.5mm bore hose on to the hose adaptor. See Fig 5 (I).
2. Route the hose back to the waterfall.

## MAINTENANCE

The Hozelock Cyprio range of Cascade pumps has been designed to allow fast and easy maintenance. As with all pumps of its kind, occasionally it will become necessary to clean the Strainer Cage and Fountain Spray head ring.

**ALWAYS UNPLUG OR DISCONNECT ALL APPLIANCES IN THE POND FROM THE ELECTRICITY SUPPLY BEFORE PUTTING YOUR HANDS IN THE WATER OR STARTING MAINTENANCE.**

### Fountain Head

1. Place a coin or similar in the slot and gently lever off the fountain head.
2. Rinse in clean water and reassemble.

### Strainer.

1. Remove the accessories from the pump outlet.
2. Holding the pump in one hand, press the release button (J) on the top of the pump and open Strainer Cage. See Fig 5.
3. Slide the pump out of its location and wash/rinse the Strainer Cage with clean water. The hinges on the Strainer Cage should also be washed clean at this time.
4. Reassemble the pump.

### Rotor Assembly

1. Remove the Strainer Cage as described above.
2. Release the Pump Chamber, Fig 7 (K), by rotating it until the two retaining tongues are clear of the lugs on the Motor Body.
3. Gently pull the Pump Chamber squarely

4. away from the Motor Body.
5. Pull the Rotor Assembly out of the Motor Body. See Fig 7 (L).
6. Wash out all of the components in clean water. **Do not use detergents or other chemical cleaners.**
7. Replace the Rotor Assembly into the Motor Body and refit the Pump Chamber and Strainer Cage.

## ALL YEAR PUMP CARE

A quick daily check should be carried out to ensure that the pump is performing satisfactorily.

**Once a week-** Remove and clean the Strainer Cage and Fountain Head in accordance with the general maintenance notes. Depending on pond water conditions, cleaning may be required more frequently.

**Once a year-** Completely disassemble the pump including the Rotor Assembly as described in the general maintenance notes and wash all components in clean, fresh water. Replace worn or broken parts.

## SPARE PARTS

Contact the Consumer Services Helpline on 0121 313 1122

Item Numbers	
1. Pump Chamber and Seal.	Z13248
2. Rotor Assembly.	3419
3. Strainer Cage.	Z13225
4. Fountain Kit.	3426

## HOZELOCK CYPRIO 3 YEAR GUARANTEE

If this pump, excluding the Rotor Assembly, becomes unserviceable within 3 years of the date of purchase it will be repaired or replaced at our option free of charge, unless in our opinion it has been damaged or

misused. Liability is not accepted for damage due to accident, improper installation or use. Liability is limited to replacement of a faulty pump. This guarantee is not transferable. It does not affect your statutory rights. To obtain the benefits of the guarantee, firstly contact Hozelock Cyprio Consumer Services who may request that the pump is sent along with proof of purchase directly to the address below.

**DAMAGE CAUSED BY RUNNING THE PUMP DRY OR BY FROST INVALIDATES THE GUARANTEE.**

## FAULT FINDING

**WARNING: ALWAYS UNPLUG OR DISCONNECT ALL APPLIANCES IN THE POND FROM THE ELECTRICITY SUPPLY BEFORE PUTTING YOUR HANDS IN THE WATER WHILST EQUIPMENT IS BEING INSTALLED, REPAIRED, MAINTAINED OR HANDLED.**

**IMPORTANT - PLEASE KEEP THIS SECTION FOR REFERENCE**

### LOW FLOW FROM PUMP

1. Ensure the Strainer Cage is clean.
2. A small diameter outlet pipe will restrict outlet flow.
3. Clear any blockages and adjust the flow controls.

### NO FLOW FROM PUMP

1. Check power supply is on.
2. Check fuse and wiring.
3. Check the Rotor Assembly is not jammed, damaged or showing signs of excessive wear.
4. Ensure the Strainer Cage is clean.

### POOR FOUNTAIN DISPLAY.

1. Clean the Fountain Head. (see maintenance).

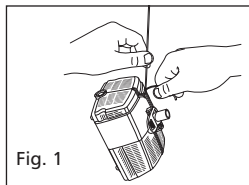

Fig. 1

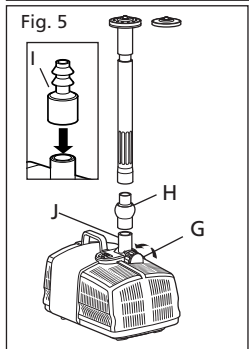

Fig. 5

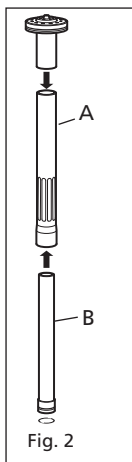

Fig. 2

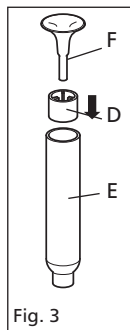

Fig. 3

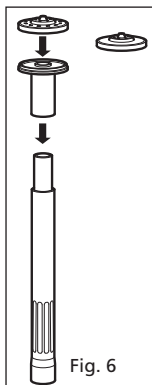

Fig. 6

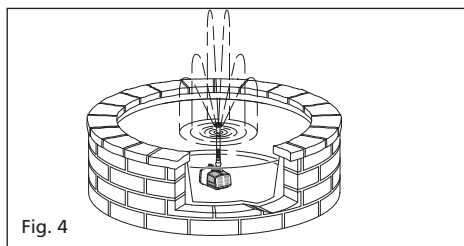

Fig. 4

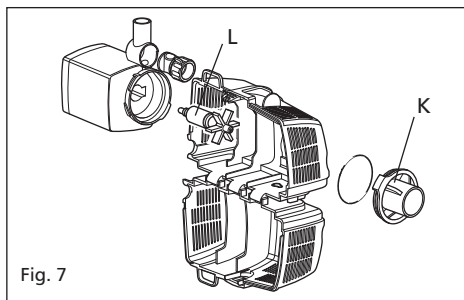

Fig. 7



**PLEASE NOTE:  
Do not dispose  
of in household  
waste**



**Hozelock Cyprio**  
Midpoint Park, Birmingham B76 1AB  
Tel: +44 (0)121 313 1122  
www.hozelock.com

The Aquatics Division of Hozelock Group

33439-002